

# SC2004A ( 20 CHARACTERS x 4 LINES )

## FEATURES

- 5 x 7 DOTS WITH CURSOR
- BUILT-IN CONTROLLER (ST7066 OR EQUIVALENT)
- 3.3V / 5.0V POWER SUPPLY
- 1/16 DUTY CYCLE
- 8-BIT PARALLEL INTERFACE

## MECHANICAL DATA

ITEM	DIMENSIONS	UNIT
Module Size ( W x H x T )	98.0 x 60.0 x 8.8 ( 12.7 LED )	mm
Viewing Area ( W x H )	77.0 x 26.3	mm
Character Size ( W x H )	2.95 x 4.75	mm
Character Pitch ( W x H )	3.55 x 5.35	mm
Dot Size ( W x H )	0.55 x 0.55	mm
Dot Pitch ( W x H )	0.60 x 0.60	mm

## INTERFACE PIN CONNECTIONS

NO.	SYMBOL	FUNCTION	NO.	SYMBOL	FUNCTION
1	V <sub>SS</sub>	Supply Ground	9	DB2	Data Bit 2
2	V <sub>DD</sub>	Supply Voltage	10	DB3	Data Bit 3
3	V <sub>O</sub>	Contrast Adj.	11	DB4	Data Bit 4
4	RS	Register Select	12	DB5	Data Bit 5
5	R/W	Read/Write	13	DB6	Data Bit 6
6	E	Enable Signal	14	DB7	Data Bit 7
7	DB0	Data Bit 0	15	A	LED Power
8	DB1	Data Bit 1	16	K	LED Power

## ELECTRICAL CHARACTERISTICS

ITEM	SYMBOL	CONDITION	MIN.	TYP.	MAX.	UNIT
LCD Operating Voltage	V <sub>DD-V<sub>O</sub></sub>	T=0	-	4.8	-	V
		T=25	-	4.5	-	V
		T=50	-	4.2	-	V
Supply Voltage	V <sub>DD-V<sub>SS</sub></sub>	-	2.7	5	5.5	V
Supply Current	I <sub>DD</sub>	-	-	4.2	7	mA
Input Voltage	"HIGH" Level	V <sub>IH</sub>	-	2.2	-	V <sub>DD</sub> V
	"LOW" Level	V <sub>IL</sub>	-	0	-	0.6 V
Output Voltage	"HIGH" Level	V <sub>OH</sub>	-	2.4	-	V
	"LOW" Level	V <sub>OL</sub>	-	-	-	0.4 V

## BLOCK DIAGRAM

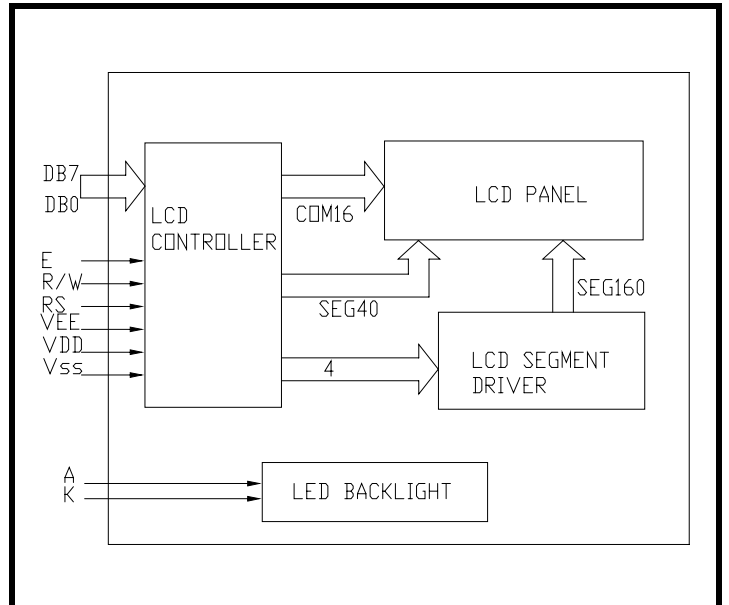

## EXTERNAL DIMENSIONS

