

SPECIFICATIONS

Current Rating: 5A AC,DC
 Voltage Rating: 250V AC,DC
 Temperature Range: -25°C to +85°C
 Contact Resistance: 10mΩ Max
 Insulation Resistance: 1000MΩ Min
 Withstanding Voltage: 1500V AC/minute
 Pin Material: Brass/Tin-plated
 Material: PBT30%GF, UL94V-0

ORDER INFORMATION

◎Standard Recommend

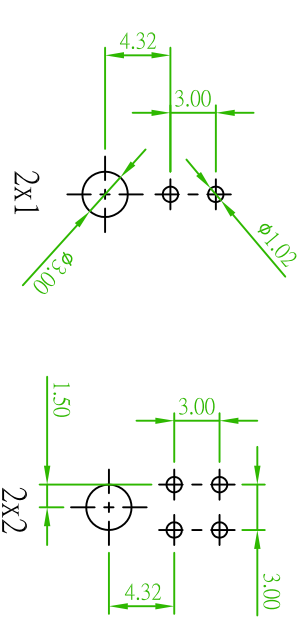
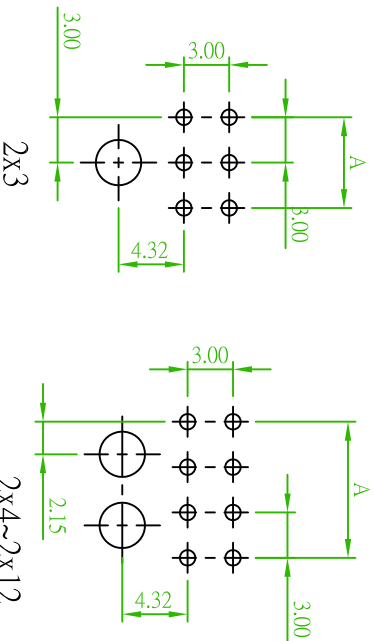
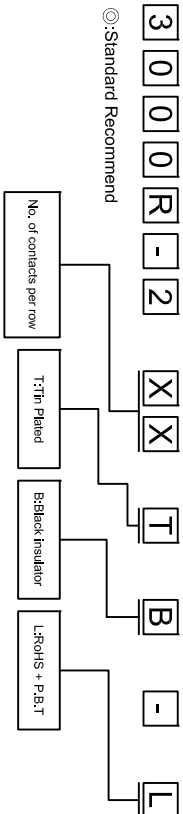

Recommended PCB Layout
 (PCB TOLERANCE ±0.05)

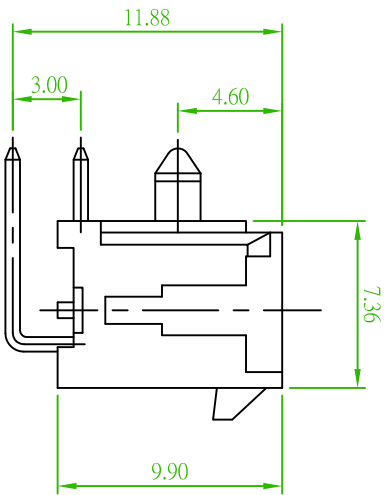
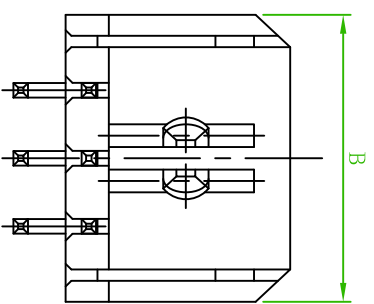
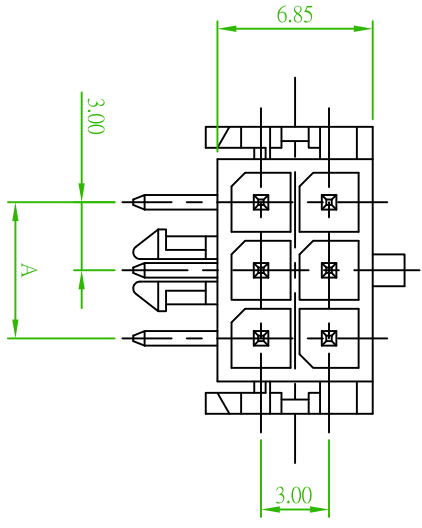

PART NO.	Dimensions	
	A	B
3000R-201TB	---	6.65
3000R-202TB	3.00	9.65
3000R-203TB	6.00	12.65
3000R-204TB	9.00	15.65
3000R-205TB	12.00	18.65
3000R-206TB	15.00	21.65
3000R-207TB	18.00	24.65
3000R-208TB	21.00	27.65
3000R-209TB	24.00	30.65
3000R-210TB	27.00	33.65
3000R211TB	30.00	36.65
3000R-212TB	33.00	39.65

AREA	REV.	DESCRIPTION	DATE

<p>Amitek Technology Co., Ltd. TEL: 886-2-2268 8086 FAX: 886-2-2268 8085</p>			
品名 TITLE	3.0mm WAFER RIGHT ANGLE		
品號 PART NO.	3000R-2XXTB-L		
圖號 DRAWING NO.	3000R-2XXTB-L		
客戶品號 CUSTOMER P/N			
公差 TOLERANCE	.X ±0.35	.XX ±0.25	單位 UNIT
			mm
日期 DATE	繪圖 DRAWN	核對 CHECKED	核准 APPROVED
09/28/2005	Kent	Paul	James

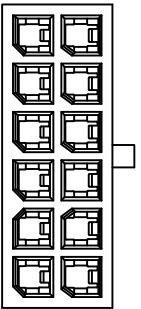

2X6P

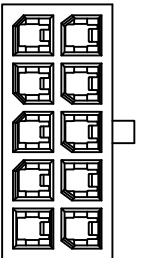

2X5P

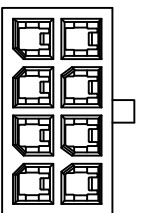

2X4P

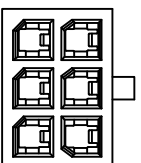

2X3P

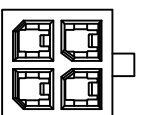

2X2P

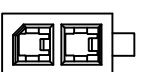

2X1P

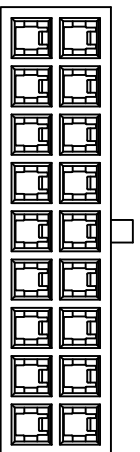

2X9P

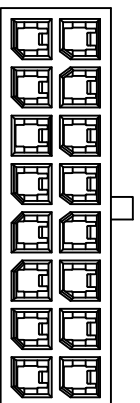

2X8P

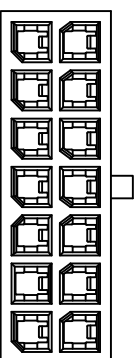

2X7P

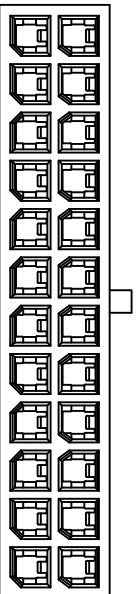

2X12P

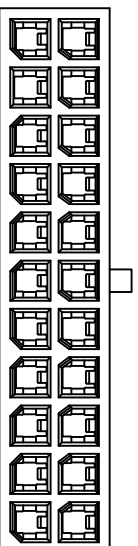

2X11P

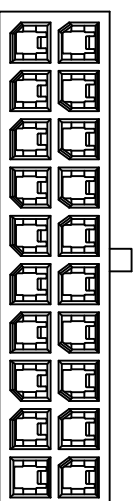

2X10P

3.0mm WAFER RIGHT ANGLE

品名 TITLE		3000R-2XXTB-L			
品號 PART NO.		3000R-2XXTB-L			
圖號 DRAWING NO.		3000R-2XXTB-L			
客戶品號 CUSTOMER P/N					
公差 TOLERANCE		.X ±0.35 .XX ±0.25		單位 UNIT	
		版本 REV.		A	
		比例 SCALE		FREE	
日期 DATE		繪圖 DRAWN		核對 CHECKED	
09/28/2005		Kent		Paul	
核對 APPROVED		James			
AREA	REV.	DESCRIPTION			
		DATE			



禮德企業有限公司
 Amtek Technology Co., Ltd.
 TEL: 886-2-2768-8052
 FAX: 886-2-2768-8055